

**RIGID PLASTIC LEVEL GAGES** can be mounted flush against the outside surface of a liquid reservoir with only a small amount of protrusion.

Liquid level gages for flush mounting are used for a multitude of applications, such as on tanks, reservoirs, packaged hydraulic equipment, large steel mill pumps, hydraulic presses, and for any other application where it is desirable to indicate liquid levels.

Liquid level gages are used to determine the liquid level inside a reservoir by visual observation of the level in a transparent sight. The clarity and condition of the liquid can easily be checked. Models with a thermometer will also show the temperature of the liquid.

Break resistant level gages show the liquid level clearly from all sides. These gages are made of clear, transparent, almost unbreakable Trogamid® nylon which can be furnished in many lengths.

Back mounting gages are used on tanks permitting access to the inside in order to fasten the nuts on the mounting studs, inserted in drilled holes in reservoirs. Front mounting gages are used on reservoirs which do NOT permit access to the inside, therefore, the tank must have two tapped holes, to receive the mounting studs, which are fastened from the outside. Many special gages have been developed for customer's specific applications.

**SPECIFICATIONS:**

- Pressure
- Temperature
- End Blocks
- Sight
- Seals
- Mounting Kits

125 P.S.I. Max. at 72° F.  
 205° F. Max.  
 Aluminum Alloy  
 Round Nylon (Trogamid®, Red Line Tape)  
 Buna-N  
 Aluminum, Plated Steel  
 (Shut-off Mounting Kits - Stem, Brass)  
**Mounting Studs Torqued to 90 IN\*LB**  
**When Installing Level Gage**

**•Torque**

Patent Number 6,532,815

**ORDERING EXAMPLE**

Please include the following:

- Gage Series
- Gage Description
- Fractional Portion of Centerline Length
- Mounting Kit
- Seal Material
- Whole inch value (3" to 36")

Example below: (B3642-1 05 16 B A1W) a Standard Flush Round Nylon Level Gage, 5-1/2" centerline length, Buna-N seals with front mounting, 1/2-20 thread size.

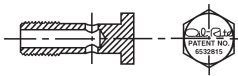
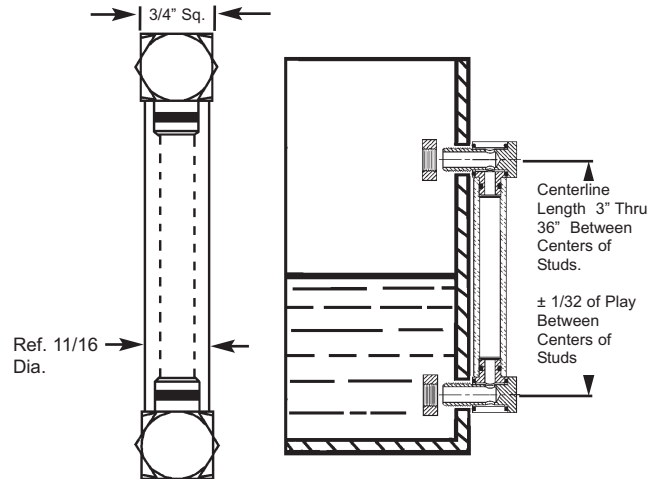
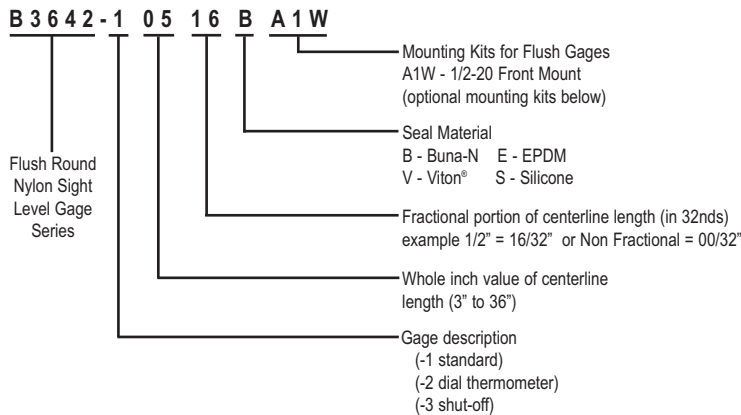

Front Mounting Bolts

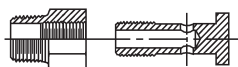

Mounting Bolts with Adapters

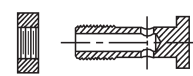

Back Mount with Mounting Nut

	Front Mount			Back Mount	with NPT Adapters			with NPTF Adapters				with NPSM Adapters				with BSPT Adapters				
	M12 x 1.75 stud	1/2-13 stud	1/2-20 stud	1/2-20 stud	3/4 NPT	1/2 NPT	3/8 NPT	1/4 NPT	3/4 NPTF	1/2 NPTF	3/8 NPTF	1/4 NPTF	3/4 NPSM	1/2 NPSM	3/8 NPSM	1/4 NPSM	3/4 BSPT	1/2 BSPT	3/8 BSPT	1/4 BSPT
Standard	M1W	A2W	A1W	B1W	N4W	N3W	N2W	N1W	F4W	F3W	F2W	F1W	P4W	P3W	P2W	P1W	R4W	R3W	R2W	R1W
Dual Scale			A1W	B1W	N4W	N3W	N2W	N1W	F4W	F3W	F2W	F1W	P4W	P3W	P2W	P1W	R4W	R3W	R2W	R1W
Shut-off			A1L	B1L	N4L	N3L	N2L	N1L	F4L	F3L	F2L	F1L	P4L	P3L	P2L	P1L	R4L	R3L	R2L	R1L

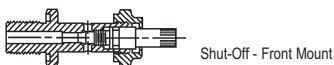

Shut-Off - Front Mount

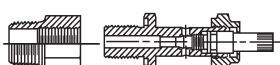

Shut-Off with Adapters

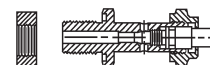

Shut-Off - Back Mount with Mounting Nut

Viton is a registered trademark of Dupont Dow Corp.  
 Trogamid is a registered trademark of Degussa AG.